

HOW TO DRY FIT LIKE A PRO



1

Gather Supplies

IMPORTANT:

Save original shipping container to ship your templates.

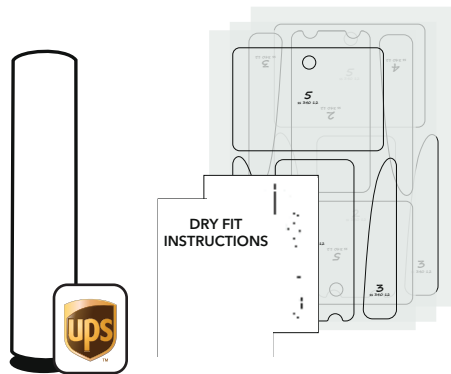

Kit Contents

- Dry fit templates
- Dry fit instructions
- Shipping label
- Boat legend

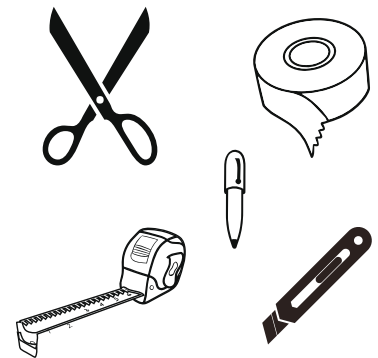

Needed Tools

- Scissors
- Masking Tape
- Tape Measure
- Utility knife (optional)
- Marker

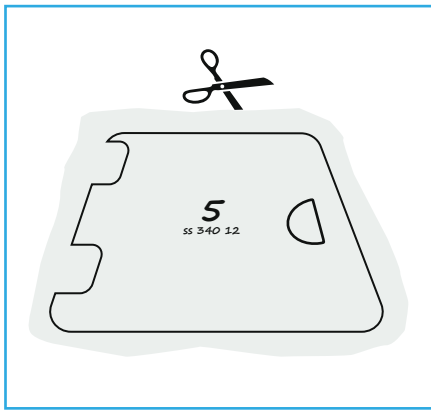
2**Templates Cut Out**

Use scissors to cut out each template part leaving as much Tracing Film as possible around each part in case you need to notate an increase in size. Templates may be pre-cut in advance.

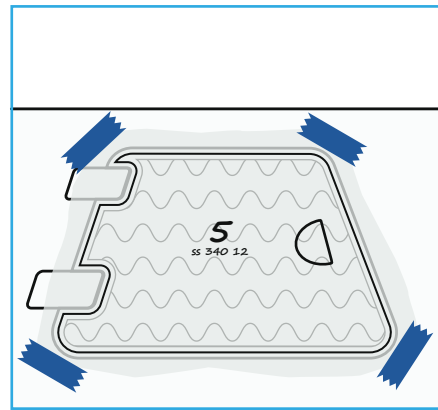
3**Templates Placement**

Place each part on your boat in the exact position to which it will be applied. *Note, if there is a molded-in pattern on your boat then the parts should be aligned to or slightly overlapping the pattern.

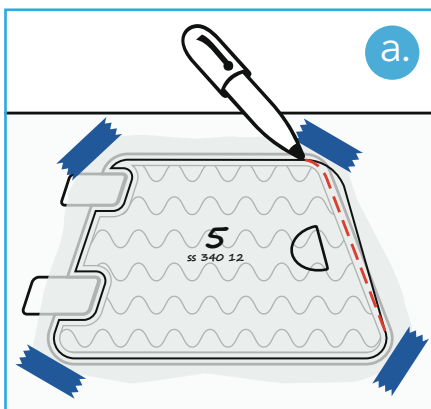
4**Templates Corrections**

Place each template in its appropriate location; if the fit isn't correct, identify changes necessary on the Tracing Film.

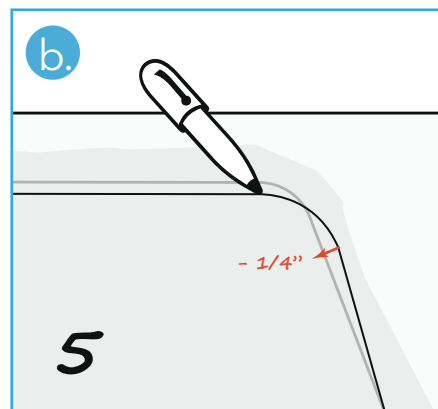

Mark template parts with the marker. If template line or part of the line need to be adjusted indicate the boundary of the adjustment, then use arrow mark to indicate inward or outward adjustment and amount of adjustment next to the arrow.

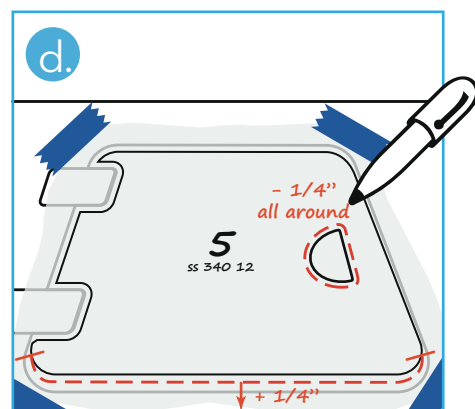
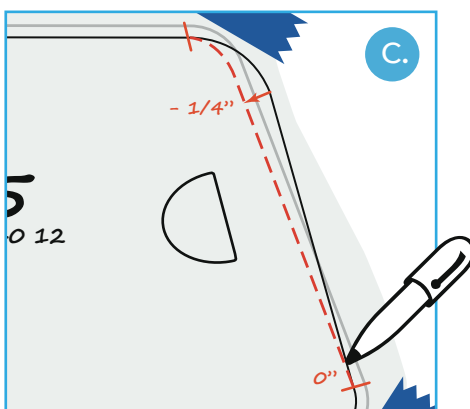

Amount need to have "+" sign for outward adjustment and "-" sign for inward adjustment. If adjustment tapers to the existing line indicate the point where the adjustment line touches original line with 0 amount and the adjustment amount on the other end of a new line.

5

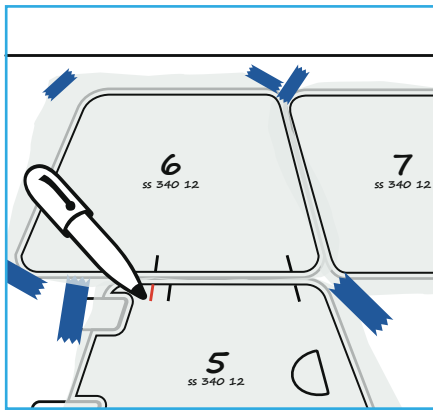

Alignment Marks

After all dry fit parts are secured on the surface check all alignment marks and make corrections as needed.

6

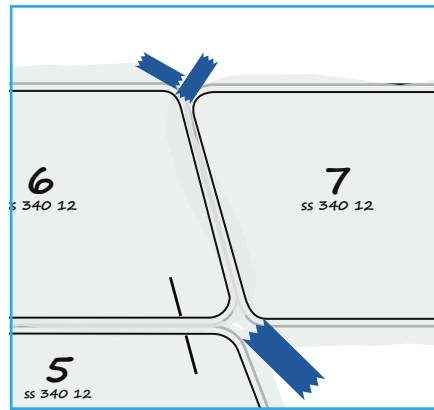

Following Patterns

Alignment marks will only be used on parts relevant to pattern alignment. If the pattern is vertical teak then marks will appear on parts vertically relative to each other. For complex patterns, marks will appear on all sides of the parts relative to each other.

6

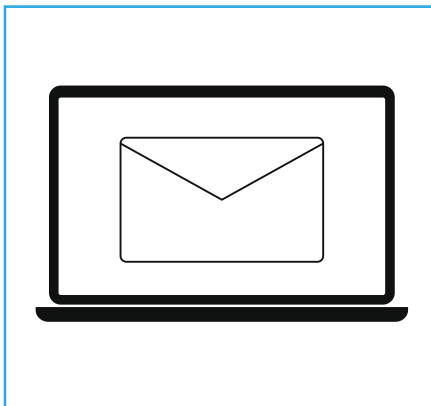

OR

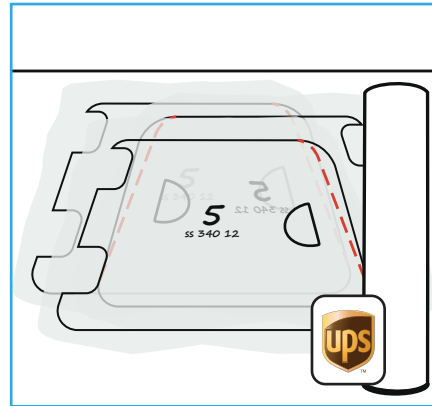

Templates Return

If dry fits are correct "As Is" there is no need to send them back. Simply reply to your original "drawing approval email" and follow the instructions provided by the sales representative.

Otherwise, use the provided label and return them to us for corrections.

Once corrections have been applied your sales representative will be in touch to proceed to the next step.

7

Photos and Shipping

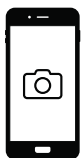

Photograph Corrected Templates

If possible, photograph each template prior to detaching.

E-mail photos to sales@topdek.com

Include your dry fit kit's order number in e-mail's subject line.



- Place templates in the original shipping container.
- Insert Boat Legend. Seal container and apply return shipping label. Copy receipt # for your records.
- Drop off at a UPS location.



DFHOW_040418